



Products and Applications

Guide for 2023



H+H
PARTNERS IN WALL BUILDING



Contents

- 01 Introduction
- 02 Building Types
- 04 Performance & Benefits
- 06 Product
- 16 Application
- 21 Solutions
- 28 Packs & Haulage

Aircrete/
aerkri:t/
noun., adj.

1. autoclaved, aerated concrete (AAC) **2.** (cel)lular (con)crete (CELCON). One of the lightest forms of concrete with structural, thermal, sound, fire and freeze/thaw properties, extensively used in Europe where known as 'gasbeton'. Used in the UK since the 1950s; today known as 'aircrete'. Comprises pulverised fuel ash (PFA), sand, cement, aluminium powder, lime and water. Used as blocks in a range of thicknesses and face formats for internal and external walls above and below dpc and as infill in beam and block floors; used as a material for reinforced floor elements.

Building the homes of tomorrow. Today.

H+H has been supplying our aircrete products into the market for over sixty years building a reputation for our distinctive partnership approach and for adding value at every stage of the supply chain.

From initial planning through design, distribution and construction, H+H supports customers at every stage of the building process, recognising that from genuine partnership comes responsive efficient and reliable customer service.

We manufacture the highest quality, technically innovative aircrete components, but more than that, we specialise in the design and construction of high-performance, durable, cost effective structural walls.

With their thermal, acoustic and load bearing capabilities, H+H products offer simple solutions to accommodate the latest Building Regulations – and looking further ahead, to meet the Future Homes Standard due to come into effect in 2025.

Our aircrete products can even accommodate the needs of technically demanding building methods such as Passivhaus. We have been working with housebuilders to develop energy efficient house designs for decades.

H+H is committed to sustainability. Up to 80% of the raw materials used in the manufacture of Celcon Blocks are recycled products in some form. We also ensure that 99% of all raw materials are sourced from UK suppliers reducing the need for transportation.

H+H Group has committed to produce net zero carbon emissions by 2050 and we are using third-party verified Science-Based Targets to measure the impact of our actions.

Since setting up our first research and development laboratory in 1969, H+H has been at the forefront of aircrete research and manufacturing.

A totally focussed strategy, combined with specialised resources, has enabled us to undertake pioneering work with solutions including Celcon Blocks, the H+H Thin-Joint System and the H+H MMC build solution with Vertical Panels.

Housing, Commercial, Public and Industrial

The complete building material

You can use H+H aircrete throughout the house from foundations to roof. H+H aircrete is designed to meet our own exacting quality standards as well as providing constructions to meet requirements of Building Regulations for internal partition walls, solid walls, cavity walls, separating walls, cavity and solid foundations and suspended floors.

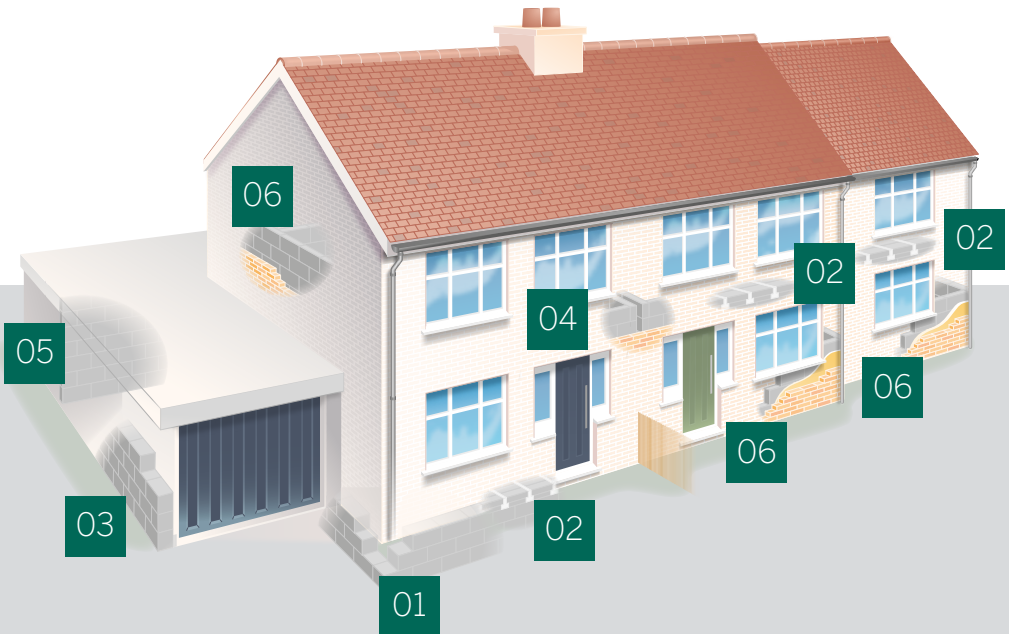

For fast and easy building (H+H's Thin-Joint aircrete offers even faster construction times), excellent acoustic and thermal resistance and a tough, durable, lightweight design, you'll find H+H aircrete is the answer.

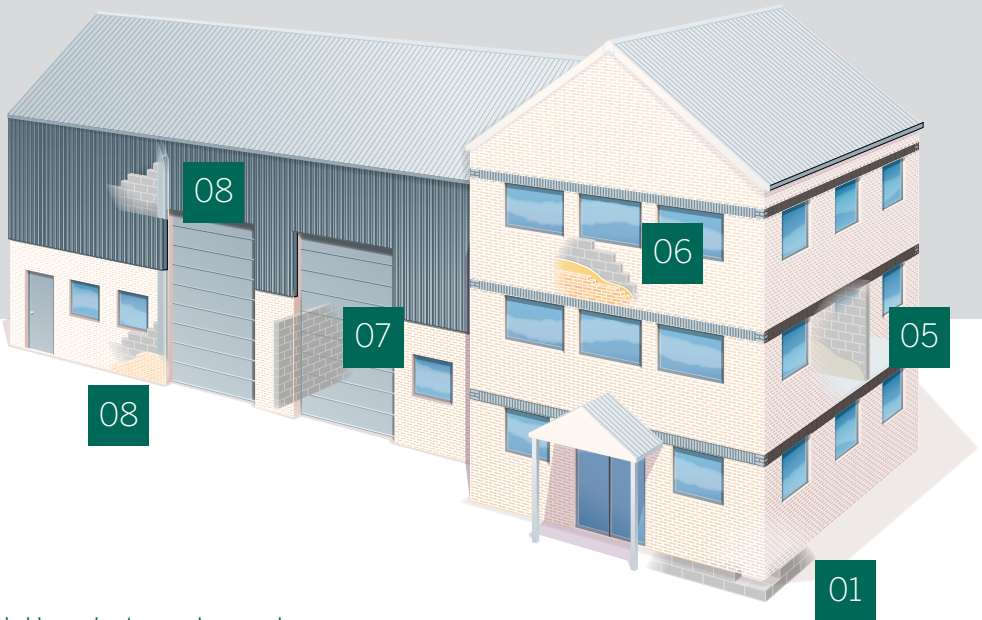

H+H products can be used to build many types of industrial and commercial buildings including; schools, offices, factories, warehouses and hospitals.

H+H aircrete can be used for many applications including foundations, partition walls, external walls (both solid and cavity) and as infill to steel and concrete framed buildings. A variety of finishes – brick, render, metal cladding etc, may be employed.

- | | |
|----------------------------------|---------------------------------------|
| 01 Solid Foundations | 05 Partition Walls |
| 02 Beam and Block floors | 06 External Cavity Walls |
| 03 Solid Wall Construction | 07 Fire Walls |
| 04 Separating and Flanking Walls | 08 Infill to steel and concrete frame |

The Ultimate Masonry Product

Build with confidence

Lightweight

- Meets CDM regulations for manual handling (except Foundation Blocks)
- Easy to transport
- Less than half the weight of the equivalent aggregate block
- Reduces the building load in high rise construction
- Can enable wider spans in beam and block floors



Strong

- Loadbearing
- Suitable for foundations of houses and low-rise flats
- Supports up to 4 storeys without a structural frame
- Block strength from 2.9N/mm² to 8.7N/mm²

Excellent Thermal Insulation

- Reduces the amount of additional insulation
- Offers enhanced thermal insulation when used in walls, foundations and beam and block floors reducing the amount of insulation required
- Significantly contributes to satisfying Part L of the Building Regulations

Thermal Mass

- Helps to create a comfortable living environment
- Provides an even temperature range in winter or summer

Airtightness

- Can be used to achieve excellent airtightness on site

Excellent Sound Insulation

- Achieves 40dB sound insulation for internal partition walls (100mm blocks)
- Comfortably satisfies Part E of the Building Regulations by Pre-Completion Testing or Robust Detail methods of compliance
- Useable in flats and apartments as well as houses

Fireproof

- Fire resistant (100mm walls, up to 4 hours, 2 hours if load-bearing)
- Class 0 surface spread of flame
- Non-combustible to Class A1 (the highest class)

Robust and Durable

- Low wear and tear
- Resists sulfate attack in foundations
- Water-resistant
- Frost-resistant
- Does not rot or decay
- Excellent ballistic impact performance
- Is not susceptible to insect attack



User-friendly

- Easy to fix to
- Can securely hold fixings for heavy loads
- Easy to work using simple hand tools
- Virtually maintenance-free
- Easy to achieve airtight construction
- Stretch wrapped for protection and tidiness
- Delivered where required on pallets for easy movement and storage

Certification

- Approved by the BBA
- CE marked, meeting the latest European Standards
- Accepted by the NHBC
- Certified under BS EN ISO 9001
- All factories are BS EN ISO 14001 compliant
- H+H Ltd was the first company to achieve 'Very good' in the BES 6001:2008 standard for the Responsible Sourcing of Construction products and is now rated as 'excellent'
- H+H has been awarded BS EN 16001 for energy efficiency and the BSI kitemark for Energy Reduction Validation (ERV)

Sustainability and The Environment

- Easy to cut, reducing on-site waste
- Made using pulverised fuel ash (an industrial by-product)
- Constructions obtain the highest rating within the Green Guide to Housing Specification
- Light weight allows greater volumes delivered at once, reducing journeys
- Most production waste material is recycled back into the manufacturing process
- Can be recycled for use as aggregate
- Made using up to 80% recycled material
- 99% of raw materials are sourced within the UK

Versatile

- Accepts a wide range of finishes
- Multi-purpose – use for entire buildings
- Adaptable for use in innovative designs
- Easy to alter or extend during or after the build process



Product



H+H aircrete products offer a complete building material that meets the requirements of the Building Regulations, with the flexibility to offer solutions to hospitals, schools, offices, industrial warehouses and housing (social and private).

Make the right choice – a simple guide



Solar Grade
(blue)





















Standard Grade
(none)

High Strength Grade
(black)

Super Strength Grade
(red)

H+H Product Range

Grade and Finish Identification

	Solar Grade* (blue)	Standard Grade (none)	High Strength Grade* (black)	Super Strength Grade* (red)
Celcon Foundation Block 325 x 215mm				
Celcon Block - Scratch Marked 440 x 215mm and Foundation Blocks (all sizes)				
Celcon Block - Plain Face 440 x 215mm				
Celcon Block Coursing Unit 215 x 65mm				
Celcon Plus Block - Plain Face 630 x 215mm				
Jumbo Bloks - Plain Face 630 x 250mm				

* Whilst the colour reference for Solar Grade, High Strength and Super Strength Grades remain consistent, the positioning of the line may vary.

Celcon Blocks

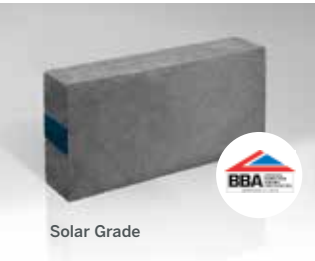

Celcon Blocks in Solar, Standard, High Strength and Super Strength Grades are the most commonly used aircrete block in the H+H range.

All Celcon Blocks are BBA certified, are fire resistant (100mm walls, up to 4 hours, 2 hours if load-bearing dependent upon the Grade) and have been classified 0 surface spread of flame and non-combustible to Class A1 (the highest class). Celcon Blocks are available in thicknesses from 75mm to 355mm Foundation Blocks and can be used in the applications listed.

For specific technical information on the Grades available in this range, please refer to pages 8 to 15.

Applications

- Internal and external leaf of cavity walls
- Solid walls
- Separating walls (except Solar Grade)
- Partitions
- Flanking walls
- Multi-storey buildings
- Foundations/Below ground level
- Beam and Block floors (except Solar Grade)

Face size	All Grades 440mm x 215mm				
Block Thickness (mm)	75	100	140	150	215
Solar Grade Weight (kg) [†]	-	5	8	8	12
Standard Grade Weight (kg) [†]	5	7	10	11	16
High Strength Grade Weight (kg) [†]	-	10	14	15	21
Super Strength Grade Weight (kg) [†]	-	10	14	15	-

	Solar Grade	Standard Grade	High Strength Grade	Super Strength Grade
Compressive Strength	2.9N/mm ²	3.6N/mm ²	7.3N/mm ²	8.7N/mm ²
Thermal Conductivity	0.11 W/mK	0.15 W/mK	0.18 W/mK	0.18 W/mK
Density	460 kg/m ³	600 kg/m ³	730 kg/m ³	730 kg/m ³

[†] Block weights at typical moisture content when laid. (Some manufacturers may quote weights which have not allowed for this.)

All shaded areas indicate that the product is a stock item. Other sizes can be made to order subject to minimum quantities.

Solar Grade

Solar Grade is principally used where enhanced thermal performance is required.

With a superior thermal conductivity Solar Grade blocks are suitable for two storey buildings and can be used below DPC. Solar Grade is available in thicknesses from 100mm to 215mm, and are third party accredited under BBA and certified for use in the applications listed.

Applications

- Internal and external leaf of cavity walls
- Solid walls
- Partitions
- Flanking walls
- Below DPC

Note: Solar Grade aircrete is identified with a blue line on the block.

Whilst the colour remains consistent, the positioning of the line may vary.

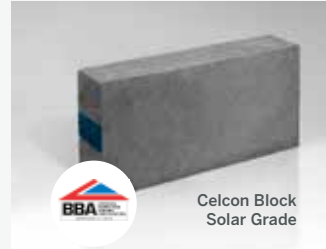

Standard Grade

Standard Grade is extremely versatile and can be used below DPC, as infill for beam and block flooring systems, as well as above the ground in the walling applications listed.

Celcon Blocks, Standard Grade are BBA certified and available in thicknesses from 75mm up to 355mm. Due to its all round performance, it is possible for 100mm Standard Grade Block to be used throughout a build – in floors and all walls eliminating any site confusion.

Applications

- Internal and external leaf of cavity walls
- Solid walls
- Separating walls
- Partitions
- Multi-storey buildings
- Foundations
- Beam and Block floors
- Flanking walls



High Strength & Super Strength Grade



High Strength Grade



Super Strength Grade

High Strength Grade and Super Strength Grade are used principally where higher compressive strengths are required such as in the foundations and lower storeys of three and four storey buildings, piers under high vertical loads and in multi-storey buildings.

Higher Strength grades are available in compressive strengths of 7.3N/mm^2 and 8.7N/mm^2 and in thicknesses from 100mm to 355mm (Super strength up to 150mm). They are third party accredited under BBA and certified for use in the applications listed.

Applications

- Internal and external leaf of cavity walls
- Solid walls
- Separating walls
- Flanking walls
- Partitions
- Multi-storey buildings
- Foundations
- Beam and shock floors



Foundation Blocks

Celcon Foundation Blocks are commonly produced in a range of thicknesses for use below ground level. Offering beneficial thermal performance, they are suitable for the support of cavity or solid walls, framed construction or suspended floors, including beam and block floors. They are resistant to damage caused by water penetration.

With exceptional resistance to freeze/thaw conditions and sulfate attack when they occur below ground level: BBA certificate 01/3816 confirms that all Celcon Foundation Blocks are suitable for use in soil conditions from DS1 to DS4.

Celcon Foundation Blocks can be laid below ground level without mortar perpend. Simply lay them with mortared horizontal bed joints and then butt them together to prevent the passage of vermin.

Solar Grade can also be used below ground (See page 9 for information).

All Celcon Foundation Blocks may also be used above ground, with appropriate finishes, for solid wall construction.

Applications

- Foundations
- Solid wall construction



Face size	Standard Grade 440mm x 215mm			High Strength Grade 440mm x 215mm		
	Block Thickness (mm)	275	300	355	275	300
Block Weight (kg) [†]	20	22	26	27	29	35

Face size	Standard Grade 325mm x 215mm		High Strength Grade 325mm x 215mm	
	Block Thickness (mm)	300	300	300
Block Weight (kg) [†]	16	16	16	16

Face size	Standard Grade		High Strength Grade	
	Compressive Strength	3.6N/mm ²	7.3N/mm ²	7.3N/mm ²
Thermal Conductivity	0.24 W/mK*	0.29 W/mK*	0.29 W/mK*	0.29 W/mK*
Density	600 kg/m ³	730 kg/m ³	730 kg/m ³	730 kg/m ³

[†] Block weights at typical moisture content when laid. (Some manufacturers may quote weights which have not allowed for this.)

All shaded areas indicate that the product is a stock item. Other sizes can be made to order subject to minimum quantities.

24 Bold green figures indicate that the product is above single person repetitive manual handling limits.

* Please note that the thermal conductivity quoted for use below ground is different to that when used above DPC, because they may have higher moisture content.

Coursing Units



Coursing Units

Coursing units are produced from the same material and are suitable for all the same applications as conventional size Celcon Blocks, allowing consistency within the building fabric.

They are suitable for use both externally and internally in load-bearing and non load-bearing situations.

Load-bearing walls should not be constructed of Coursing Units as the only masonry unit.

Applications

- Protect against cold bridging
- Infill above doors and windows
- Coursing at floor and ceiling level
- Making up between joists

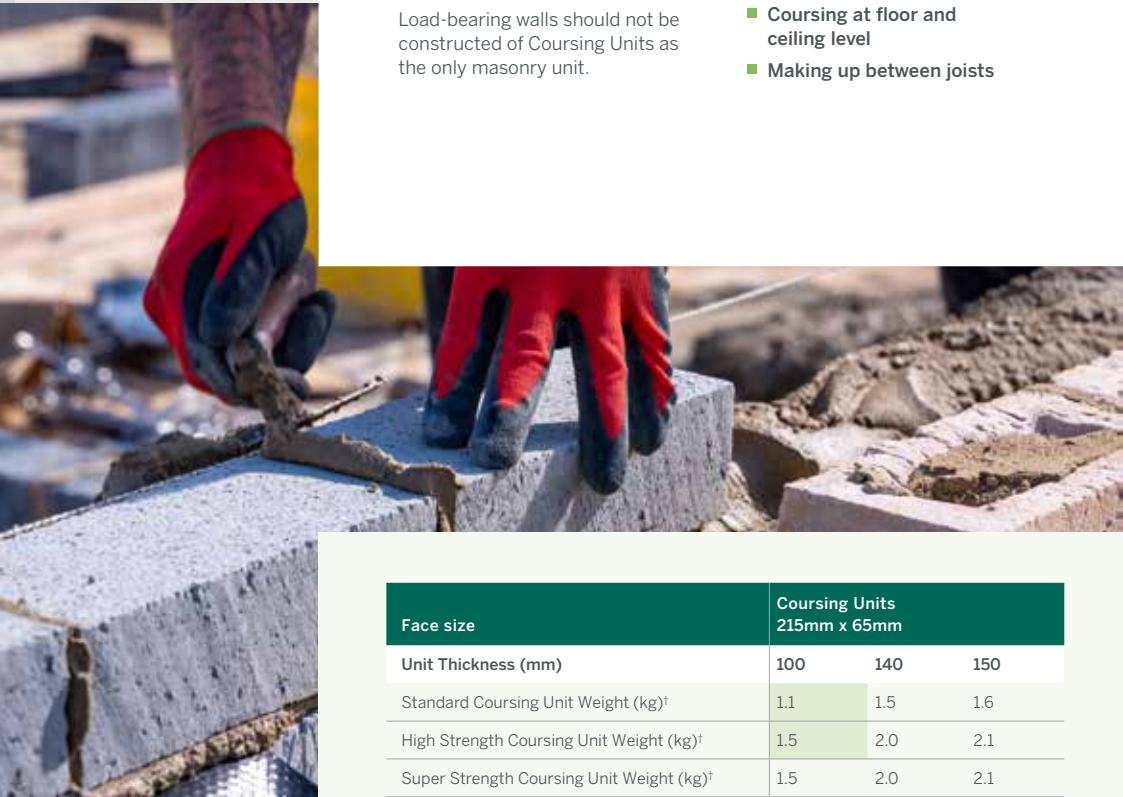

Face size	Coursing Units 215mm x 65mm		
Unit Thickness (mm)	100	140	150
Standard Coursing Unit Weight (kg) [†]	1.1	1.5	1.6
High Strength Coursing Unit Weight (kg) [†]	1.5	2.0	2.1
Super Strength Coursing Unit Weight (kg) [†]	1.5	2.0	2.1

	Standard Grade	High Strength Grade	Super Strength Grade
Compressive Strength	3.6N/mm ²	7.3N/mm ²	8.7N/mm ²

Celcon Plus Blocks

Celcon Plus Blocks are 630mm long and provide an alternative to the 440 x 215mm face format block and are suitable for similar applications (see below).

This range is produced using the latest manufacturing technology which rank them amongst the most dimensionally accurate blocks available.

Celcon Plus Blocks are available in Solar Grade 2.9N/mm², Standard Grade 3.6N/mm², High Strength Grade 7.3N/mm² and Super Strength Grade 8.7N/mm².

Applications

- Internal and external leaf of cavity walls
- Solid walls
- Separating walls (except Solar Grade)
- Flanking walls
- Partitions
- Multi-storey buildings
- Foundations

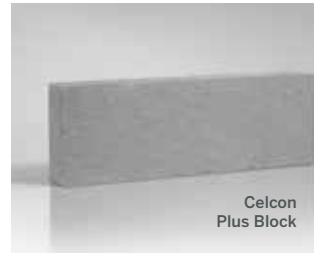

Face size	Celcon Plus Blocks 630mm x 215mm				
Block Thickness (mm)	100	140	150	200	215
Solar Grade Weight (kg) [†]	8	11	12	16	17
Standard Grade Weight (kg) [†]	10	14	15	20	-
High Strength Grade Weight (kg) [†]	12	17	18	24	-
Super Strength Grade Weight (kg) [†]	12	17	18	24	-

	Solar Grade	Standard Grade	High Strength Grade	Super Strength Grade
Compressive Strength	2.9N/mm ²	3.6N/mm ²	7.3N/mm ²	8.7N/mm ²
Thermal Conductivity	0.11 W/mK	0.15 W/mK	0.18 W/mK	0.18 W/mK
Density	460 kg/m ³	600 kg/m ³	730 kg/m ³	730 kg/m ³

[†] Block weights at typical moisture content when laid. (Some manufacturers may quote weights which have not allowed for this.)

All shaded areas indicate that the product is a stock item. Other sizes can be made to order subject to minimum quantities.

24 Bold green figures indicate that the product is above single person repetitive manual handling limits.

Jumbo Bloks



H+H Jumbo Bloks offer beneficial productivity, with as few as 6.3 blocks completing 1m² of walling. Their use with thin layer construction enhances the speed of build on site.

Applications

- Internal and external leaf of cavity walls
- Separating walls (except Solar Grade)
- Flanking walls
- Partitions
- Multi-storey buildings

Face size	Jumbo Blok 630mm x 250mm	
Block Thickness (mm)	100	140
Solar Grade Weight (kg) [†]	9	13
Standard Grade Weight (kg) [†]	12	17
High Strength Grade Weight (kg) [†]	14	20
Super Strength Grade Weight (kg) [†]	14	20

	Solar Grade	Standard Grade	High Strength Grade	Super Strength Grade
Compressive Strength	2.9N/mm ²	3.6N/mm ²	7.3N/mm ²	8.7N/mm ²
Thermal Conductivity	0.11 W/mK	0.15 W/mK	0.18 W/mK	0.18 W/mK
Density	460 kg/m ³	600 kg/m ³	730 kg/m ³	730 kg/m ³

† Block weights at typical moisture content when laid. (Some manufacturers may quote weights which have not allowed for this.)

All shaded areas indicate that the product is a stock item. Other sizes can be made to order subject to minimum quantities.

Vertical Panels

H+H Vertical Panels are a new generation of mechanically handled aircrete product that builds on the efficiency of thin-layer construction. These products offer all the benefits of aircrete material with proven site productivity.

Developed to enhance the key benefits of our thin-joint system; speed and quality of build with reduced waste, H+H UK's Vertical Panels offer all the attributes of aircrete as a building material whilst offering additional value to the project.

H+H Vertical Panels are made to extremely tight manufacturing dimensional tolerances, supplied specifically for use with a combination of ancillary products and bonded using H+H's proprietary element mortar to provide a nominal 3mm joint. This ensures a quality and quick build with little or no site wastage.

H+H Vertical Panels are sold as a package including most materials required to build the walls and priced accordingly.

Applications

- Excellent thermal insulation
- Excellent fire resistance
- Strong
- Good Thermal Mass
- Airtight
- Excellent Sound insulation
- Robust and Durable
- Lightweight
- Sustainable
- User friendly
- Design flexibility



Dimensions (mm) (LxHxT)	600 x 2325 x 100
Strength* (N/mm ²)	4.0
Density (kg/m ³)	575
Thermal Conductivity (W/mK)	0.17

* Strength quoted in accordance with EN12602

Application

Our blocks are designed to be used in both traditional and specific Modern Methods of Construction to increase the efficiency of the building process and enhance the performance of the finished project.



Below Ground

Heat loss from ground floors is most critical at their perimeter. H+H's range of Foundation Blocks can significantly improve thermal performance and reduce heat loss when used below ground level.

H+H Foundation Blocks are available in a range of thicknesses designed for the foundation walls, from concrete footings up. They are equally suitable for the support of cavity walls, solid walls and timber-framed construction.

H+H Foundation Blocks will reduce additional insulation; trenches can be back filled as soon as installation is complete, usually the same day.

The raw materials used in the production of Celcon Foundation Blocks give them their excellent resistance to sulfate attack and frost damage, thus making them ideal for use below ground in soil conditions unsuitable for many other types of masonry.

BBA appraisal includes assessment of the resistance of the Celcon Blocks to the freeze/thaw conditions likely to occur below ground level.

Celcon Foundation Blocks are easy to handle, have third party accreditation from the British Board of Agrément (BBA) and are deemed suitable for use by the NHBC and have Local Authority Building Control (National) type approved certification.

Foundation Blocks

- **One Celcon Foundation Block replaces two 100mm concrete blocks**
- **Trenches can be back filled as soon as installation is complete**
- **Impressive load-bearing capabilities can be achieved for multi-storey buildings**
- **Weigh a third of an equivalent dense aggregate block**
- **No cavity ties required or mortar mix in the cavity**
- **No need to mortar perp joints – blocks can be dry butted at perps**

External Walls

External walls can be built using either cavity or solid construction, with each having distinct advantages in specific situations.

Solid Walls

Solid walls are a very fast and effective solution for wall construction, which is rapidly gaining popularity. H+H aircrete's close cell structure results in excellent resistance to water penetration and easily meets the requirements of Part C of the Building Regulations.

In solid wall construction H+H aircrete can be used with a variety of external finishes such as render, brick slips and cladding systems. Additional insulation can be added by the use of proprietary insulated systems and/or insulated plaster board.

Cavity Walls

In a cavity external wall construction each leaf fulfills specific requirements. The external leaf protects the structure from the penetration of moisture whilst the inner leaf provides the main structural support of the building. The overall wall construction must also meet the thermal requirements of the Building Regulations.

The combination of H+H aircrete's moisture resistance, strength and thermal insulation performance means they can be used for both the internal and the external (with appropriate finish) leaves of a cavity wall. This provides the designer with a wide choice of solutions using H+H products for most types of building, from residential and commercial to industrial walls are value engineered and free from technical risk.



Flooring

H+H aircrete is ideally suited as an infill for beam and block flooring systems.

Beam and block floors constructed using Celcon Blocks, are lightweight, easy, quick and safe to lay and provide a significant contribution to energy conservation due to their inherent thermal properties.

When used as a floorblock 100mm Celcon Blocks are recommended for infill. Celcon Blocks Standard Grade 440 x 215mm aircrete is

covered by a BBA certificate for use as infill in beam and block floors.

In addition, Celcon Block High Strength Grade can also be used successfully as floorblocks within the beam and block system.

When used as floorblocks, Celcon Blocks will also further improve thermal insulation in conjunction with H+H Foundation Blocks.



Internal Walls

H+H aircrete is ideal for use in partitions between rooms and for separating walls between flats, apartments and houses.



Separating Walls and associated Flanking W7s

H+H aircrete has excellent sound insulation properties and is suitable for the construction of separating walls and their associated flanking walls, allowing continued use of familiar construction methods.

Solutions meeting the requirements of Part E of the Building Regulations are available using either Pre Completion Testing (PCT) or the Robust Detail (RD) methods of compliance for both houses and flats or apartments. Many aircrete RD constructions also achieved the high credit ratings from the previous Code for Sustainable Homes (CfSH).

Internal Partition Walls

H+H aircrete is ideally suited for the construction of both loadbearing and non-loadbearing internal walls. Using H+H products creates a more robust partition, adding overall rigidity to the structure making it less prone to damage and easier to fix to than studwork.

Due to the lightweight nature of H+H aircrete, timber joists can support partitions constructed from aircrete. The joists must be properly designed and sized to suit the span and loading. Steel or concrete beams, concrete floors or beam and block floors can also support aircrete partitions.

H+H aircrete partitions easily meet the sound insulation requirements of current Building Regulations.

Celfix Mortar

With an initial bond time of around 15 minutes, storey height panels of masonry can be achieved in one lift and structurally loaded within 1-2 hours.

Celfix is supplied by H+H, dry in 25kg bags and should be added to water (approx. 4.5 litres per bag). Applied with either a scoop or sledge to maintain a consistent joint thickness of 2mm, it remains workable within the bucket for several hours.

When working in winter conditions, it is possible to lay Celfix mortar in temperature of 0°C and rising.

Applications

- Cavity walls (internal and external leaf)
- Solid walls
- Partition walls
- Separating walls
- Flanking walls
- Multi-storey buildings

* Representative sample of block sizes only. Please note that these figures are based on experience of 'typical' yield figures for a single bag of 25kg Celfix when constructing Thin-Joint blockwork on site. These yields will vary with site requirements and operative technique or ability.

Celfix Mortar Approximate yield per 5kg bag – 2mm joints			
Block Thickness (mm)*		100	140
Plus Block 630 x 215mm (7.29 blocks/m ² laid)	m ² blockwork	6.86	4.90
	No. of blocks	50.0	35.7
Jumbo Block 630 x 250mm (6.28 blocks/m ² laid)	m ² blockwork	7.65	5.46
	No. of blocks	48.0	34.2

Traditional Mortar System

As a general rule, cement: lime: sand mortars give a stronger bond than plasticised mortars of a similar compressive strength.

Mortar designation (M4) is the strongest that should be used with traditional block-work above DPC level and is generally suitable, provided structural considerations do not demand a stronger mix and the masonry is protected during construction from saturation and freezing.

Below DPC level, mortars of designation (M6) (1:½:4 cement: lime: sand) particularly where there is a risk of freeze/thaw, or (M4) may be used, according to soil conditions.



Recommended Mortar Types			
Type of Mortar	Proportion by volume	Mortar Strength	
		Designation	Class
Celfix (thin layer) Mortar	-	-	M10
Cement:lime:sand	1:½:4*	(ii)*	M6*
Cement:lime:sand	1:1:6	(iii)	M4
Cement:sand with plasticiser	1:6	(iii)	M4
Masonry cement:sand	1:5	(iii)	M4

* For use below DPC

Note: H+H does not supply materials required to create traditional mortar



Thin-Joint System



Benefits

- Fast setting mortar
- No mortar 'swimming' allowing continuous laying
- Ease of mixing and laying mortar
- Dimensionally highly accurate blocks
- First fix trades can be brought forward
- Larger block formats used

H+H aircrete products can be bonded using either traditional mortar or by using Celfix mortar, provided by H+H, ideally suited to the Thin-Joint System.

The H+H Thin-Joint System combines the range of high quality accurately dimensioned aircrete Jumbo Bloks and other formats, with Celfix, a specially developed thin layer mortar.

A classified Modern Method of Construction (MMC), this well-established BBA approved system utilises the fast setting Celfix mortar. Celfix allows a building to be constructed faster and to a better quality, with follow-on trades able to start work sooner in a weatherproof environment.

Quality

The improvements in build quality gained from the use of the Thin-Joint System are:

- Improved thermal performance
- Improved stability during construction
- Improved build accuracy of finished walls
- Reduction of site wastage
- Cleaner cavities

Speed

The Thin-Joint System allows construction times equivalent to off-site system-build solutions, without their associated lead times.

Flexibility

As with traditional building methods, the construction is carried out on site. This allows the builder to overcome problems which may have been overlooked or changed since the design stage and simplifies modifications to the building should it need to be extended or adapted to suit future lifestyles.

Applications

- Cavity walls (internal and external leaf)
- Solid walls
- Partition walls
- Separating walls
- Flanking walls
- Multi-storey buildings



Solutions



H+H aircrete is a versatile, light and easy to use product used in the building industry from foundations to internal walls.

Simple Solutions to Building Regulations (sound)

H+H UK products can easily achieve the requirements of National Building Regulations and Standards.

Excellent sound insulation qualities, which allow continued use of familiar construction methods with only minimal modifications to achieve the regulations for internal walls, floors and separating (party) walls and flanking walls.

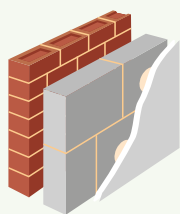

Flanking Wall

100mm Any Celcon Block
Any finish

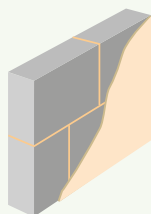

Internal Partition Wall

100mm Celcon Block Standard Grade
Any finish ($R_w = 40\text{dB}$)

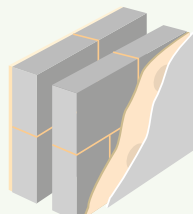

Separating Wall

See Pages 25-27

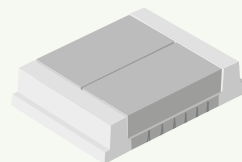

Internal Beam and Block Floor

Minimum 40mm screed (sand/cement)

100mm Celcon Block Standard Grade 440 x 215mm
12.5mm plasterboard ceiling ($R_w = 40\text{dB}$)

Simple Solutions to Building Regulations (Thermal)

Below are just a small sample of the wall solutions available with H+H aircrete blocks.

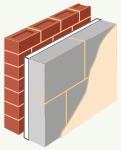
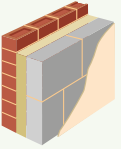
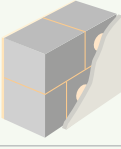
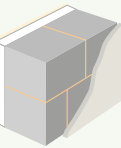
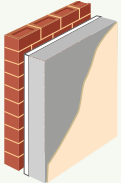
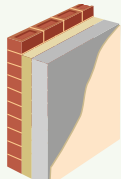
	0.28W/m²K	0.25W/m²K	0.22W/m²K
	Partial Fill Cavity Brick outer leaf Clear cavity 40mm Kingspan TW50 100mm Standard Grade Plasterboard on dabs 0.28W/m²K	Partial Fill Cavity Brick outer leaf Clear cavity 50mm Kingspan TW50 100mm Standard Grade Plasterboard on dabs 0.25W/m²K	Partial Fill Cavity Brick outer leaf Clear cavity 65mm Kingspan TW50 100mm Standard Grade Any finish* 0.22W/m²K
	Fully Filled Cavity Brick outer leaf 100mm Dritherm 37 100mm Standard Grade Any finish* 0.28W/m²K	Fully Filled Cavity Brick outer leaf 100mm Dritherm 32 100mm Standard Grade Any finish* 0.25W/m²K	Fully Filled Cavity Brick outer leaf 125mm Dritherm 34 125mm Standard Grade Plasterboard on dabs 0.22W/m²K
	Solid Wall – Internal Insulation Render finish 215mm Solar Grade 47.5mm Kingspan K118 0.27W/m²K	Solid Wall – Internal Insulation Render finish 215mm Solar Grade 52.5mm Kingspan K118 0.25W/m²K	Solid Wall – Internal Insulation Render finish 215mm Solar Grade 62.5mm Kingspan K118 0.22W/m²K
	Solid Wall – External Insulation Render finish 70mm EPS* OR 40mm Kingspan K5 215mm Solar Grade Any finish* 0.28W/m²K	Solid Wall – External Insulation Render finish 85mm EPS* OR 45mm Kingspan K5 215mm Solar Grade Any finish* 0.25W/m²K	Solid Wall – External Insulation Render finish 105mm EPS* OR 55mm Kingspan K5 215mm Solar Grade Any finish* 0.22W/m²K
	Partial Fill Cavity Brick outer leaf Clear cavity 40mm Kingspan TW50 100mm H+H Vertical Panels Any finish* 0.28W/m²K	Partial Fill Cavity Brick outer leaf Clear cavity 50mm Kingspan TW50 100mm H+H Vertical Panels Plasterboard on dabs 0.25W/m²K	Partial Fill Cavity Brick outer leaf Clear cavity 60mm Kingspan TW50 100mm H+H Vertical Panels Plasterboard on dabs 0.22W/m²K
	Fully Filled Cavity Brick outer leaf 100mm Dritherm 37 100mm H+H Vertical Panels Plasterboard on dabs 0.27W/m²K	Fully Filled Cavity Brick outer leaf 100mm Dritherm 32 100mm H+H Vertical Panels Plasterboard on dabs 0.24W/m²K	Fully Filled Cavity Brick outer leaf 125mm Dritherm 37 100mm H+H Vertical Panels Plasterboard on dabs 0.22W/m²K

* Any internal finish assumes dense plaster as worst case. Lightweight plaster or Plasterboard on dabs may also be used
 * EPS insulation assumed to be tongue and groove or lapped jointed
 Above U-values are not exhaustive, please contact our Technical Department for other constructions or grades of block not shown

H+H products' high thermal performance allows cost effective solutions to meet the current and increasingly stringent future requirements of Part L of the Building Regulations (England and Wales) and Section 6 of the Technical Handbook to the Building (Scotland) Regulations.

0.20W/m ² K	0.18W/m ² K	0.15W/m ² K
Partial Fill Cavity Brick outer leaf Clear cavity 75mm Kingspan TW50 100mm Standard Grade Any finish* 0.20W/m²K	Partial Fill Cavity Brick outer leaf Clear cavity 90mm Kingspan TW50 100mm Standard Grade Any finish* 0.18W/m²K	Partial Fill Cavity Brick outer leaf Clear cavity 125mm Kingspan TW50 100mm Standard Grade Any finish* 0.15W/m²K
Fully Filled Cavity Brick outer leaf 125mm Dritherm 32 100mm Standard Grade Any finish* 0.20W/m²K	Fully Filled Cavity Brick outer leaf 150mm Dritherm 32 100mm Standard Grade Any finish* 0.18W/m²K	Fully Filled Cavity Brick outer leaf 125mm Xtratherm CavityTherm 100mm Standard Grade Any finish* 0.15W/m²K
Solid Wall – Internal Insulation Render finish 215mm Solar Grade 72.5mm Kingspan K118 0.20W/m²K	Solid Wall – Internal Insulation Render finish 215mm Solar Grade 87.5mm Kingspan K118 0.18W/m²K	Solid Wall – Internal Insulation Render finish 215mm Solar Grade 102.5mm Kingspan K118 0.15W/m²K
Solid Wall – External Insulation Render finish 120mm EPS* OR 65mm Kingspan K5 215mm Solar Grade Any finish* 0.20W/m²K	Solid Wall – External Insulation Render finish 140mm EPS* OR 75mm Kingspan K5 215mm Solar Grade Any finish* 0.18W/m²K	Solid Wall – External Insulation Render finish 180mm EPS* OR 95mm Kingspan K5 215mm Solar Grade Any finish* 0.15W/m²K
Partial Fill Cavity Brick outer leaf Clear cavity 70mm Kingspan TW50 100mm H+H Vertical Panels Plasterboard on dabs 0.20W/m²K	Partial Fill Cavity Brick outer leaf Clear cavity 85mm Kingspan TW50 100mm H+H Vertical Panels Any finish* 0.18W/m²K	Partial Fill Cavity Brick outer leaf Clear cavity 90mm Kingspan K108 100mm H+H Vertical Panels Lightweight plaster 0.15W/m²K
Fully Filled Cavity Brick outer leaf 125mm Dritherm 32 100mm H+H Vertical Panels Any finish* 0.20W/m²K	Fully Filled Cavity Brick outer leaf 100mm Xtratherm Cavitytherm 100mm H+H Vertical Panels Plasterboard on dabs 0.18W/m²K	Fully Filled Cavity Brick outer leaf 100mm Xtratherm Cavitytherm 100mm H+H Vertical Panels 40mm Thermaline Plus 0.15W/m²K

Extensions

For extensions to existing dwellings 0.18W/m²K would be appropriate for England, 0.22W/m²K for Scotland and 0.13W/m²K for Wales.



Simple Solutions to Building Regulations (Structure)



Guidance for block strengths suitable for low rise housing is given in Approved Document A to the Building Regulations (England and Wales), the Small Buildings Structural Guidance document for the Building (Scotland) Regulations and BS 8103-2.

These documents give simple rules and guidance on block strength requirement based on various criteria including limiting dimensions for wall heights, lengths, openings and floor/roof spans.

The structural requirements are summarised below. It should be remembered that structural calculations can still be carried out, which may lead to more economical solutions.

Declared Compressive Strength of H+H Products

	Solar Grade	Standard Grade	High Strength Grade	Super Strength Grade
BS EN 771-4	2.9N/mm ²	3.6N/mm ²	7.3N/mm ²	8.7N/mm ²

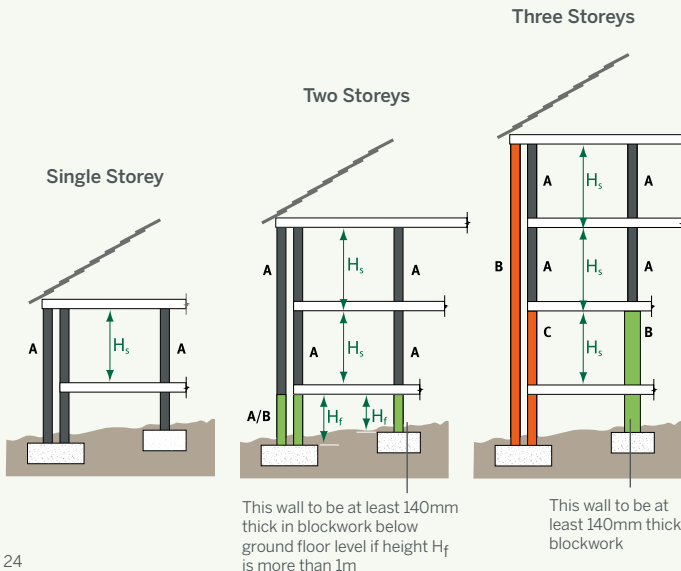

Notes

1. If H_s is not more than 2.7m, the compressive strength of blocks used in the wall should be as indicated by the key.
2. If H_s is more than 2.7m, the compressive strength of blocks used in the wall should be at least Condition B, or as indicated by the key whichever is greater.
3. If the external wall is solid construction, the blocks should have a compressive strength of at least that shown for the internal leaf of a cavity wall in the same position.
4. Timber roof construction, 12m max span.
5. Timber or concrete floor, 6m max span.
6. Wall lengths 12m max.

This diagram is taken from Figure 12 and Table 5 of BS 8103-2

Key: Min Strength

- A** 2.9N/mm² where H_s is 2.7m max
- A/B** H_s less than or equal to 1m – 2.9N/mm²
 H_s greater than 1m – 7.3N/mm²
- B & C** 7.3N/mm²

Robust Details for Acoustic Performance

What is a Robust Detail?

A Robust Detail, for Part E of Building Regulations, is a separating wall or floor construction which has been assessed and approved by Robust Details Limited (RDL).

In order to be approved, each Robust Detail must:

- Be capable of consistently exceeding the performance standards given in Approved Document E to the Building Regulations for England and Wales
- Be practicable to build
- Be reasonably tolerant to workmanship

Robust Detail designs are pre-tested to higher standards than those required by Approved Document E of the Building Regulations before being approved by Robust Details Limited (RDL). Therefore, if you register your build with RDL and build in compliance with Robust Details, you won't have to carry out pre-completion sound testing.



E-WM-6 Separating Wall – Cavity Masonry

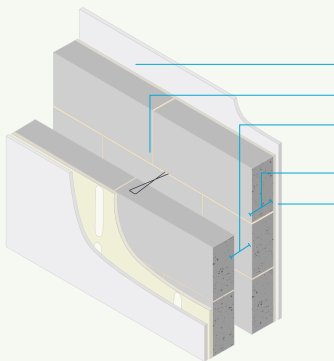

Aircrete blocks

Render and gypsum-based board on dabs

Block type	H+H Standard or High Strength Grades
Wall ties	Approved Document E Tie Type A
Cavity width	75mm (min) (may be clear or fully insulated with mineral wool with a maximum density of 40 kg/m ³)
Block thickness	100mm (min) each leaf
Wall finish	Gypsum-based board (nominal 8 kg/m ² mounted on dabs on cement:sand render (nominal 8mm) with scratch finish. Render mix must not be stronger than 1:1:6 and not stronger than background
External (flanking) wall	Masonry (both leaves) with 50mm (min) cavity – clear, fully filled or partially filled with insulation

Note: All RDL Information provided here is accurate at the time of going to press. For details of any changes and to keep up to date with current assessments, visit www.robustdetails.com

Robust Details for Acoustic Performance (Continued)

E-WM-10 & 13 Separating Wall – Cavity Masonry (thin joint)

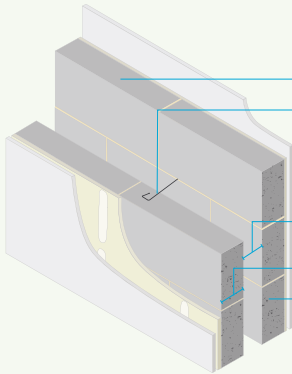

Aircrete Thin-Joint System

Render and gypsum-based board on dabs

- Block type** H+H Standard or High Strength Grades
- Wall ties** **For E-WM-10**, wall ties must be Ancon Building Products Staifix HRT4 or Clan PWT4 installed at not more than 2.5 ties per square metre
For E-WM-13, no wall ties are to be inserted in the separating wall
- Cavity width** 75mm (min) (may be clear or fully insulated with mineral wool with a maximum density of 40 kg/m³)
- Block thickness** 100mm (min) each leaf
- Wall finish** Gypsum-based board (nominal 8 kg/m²) mounted on dabs on cement:sand render (nominal 8mm) with scratch finish. Render mix must not be stronger than 1:1:6 and not stronger than background
- External (flanking) wall** Masonry (both leaves) with 50mm (min) cavity – clear, fully filled or partially filled with insulation

E-WM-15 Separating Wall – Cavity Masonry

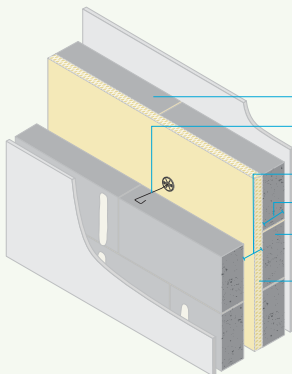

Aircrete blocks

35mm (minimum) Saint Gobain-Isover RD35 Acoustic Batt
Gypsum-based board (nominal 9.8 kg/m²) on dabs (no render parge coat)

- Block type** H+H Standard or High Strength Grades
- Wall ties** Insulation retaining wall ties to Approved Document E 'Tie type A'
- Cavity width** 75mm (min) leaf-to-leaf
- Block thickness** 100mm (min) each leaf
- Wall finish** Gypsum-based board (nominal 9.8 kg/m²) mounted on dabs
- Insulation** 35mm (min) Isover RD35 mineral wall acoustic batt
- External (flanking) wall** Masonry (both leaves) with 50mm (min) cavity – clear, fully filled or partially filled with insulation

Note: All RDL Information provided here is accurate at the time of going to press. For details of any changes and to keep up to date with current assessments, visit www.robustdetails.com

E-WM-23 +24 +30 Separating Wall – (traditional or thin joint)

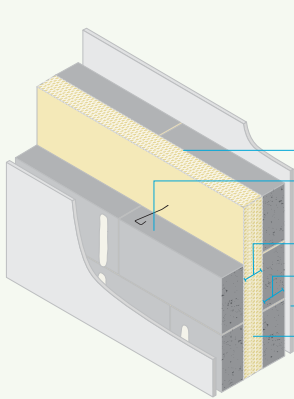

Aircrete blocks

- 100mm (minimum) Superglass Party Wall Roll (E-WM-23 only)
- 100mm (minimum) Isover RD Party Wall Roll (E-WM-24 only)
- 100mm (minimum) Knauf Supafil Party Wall Roll (E-WM-30 only)
- Gypsum-based board (nominal 8.0 kg/m²) on dabs (no render parge coat)

- Block type** H+H Standard or High Strength Grades
- Wall ties** Ties to Approved Document E 'Tie type A'. For thin joint, wall ties must be Ancon Building products Staifix HRT4 or Clan PWT4
- Cavity width** 100mm (min) leaf-to-leaf
- Block thickness** 100mm (min) each leaf
- Wall finish** Gypsum-based board (nominal 8.0 kg/m²) mounted on dabs
- Insulation** Superglass Party Wall Roll (E-WM-23 only)
Isover RD Party Wall Roll (E-WM-24 only)
Knauf Supafil 40 Cavity Wall Insulation (E-WM-30 only)
- External (flanking) wall** Masonry (both leaves) with 50mm (min) cavity – clear, fully filled or partially filled with insulation

E-WM-31 Separating Wall – Celcon Elements Panels 100mm (min)

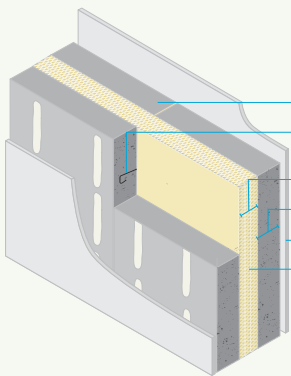

Attached houses only

- H+H - Celcon Elements - thin joint
- Gypsum-based board on dabs

- Element density** 575 kg/m³
- Wall ties** Wall ties must be Vista VE4, Ancon Building Products Staifix HRT4 or Clan PWT4 installed at no more than 3 ties per storey height
- Cavity width** 100mm (min)
- Element thickness** 100mm (min) each leaf
- Wall finish** Gypsum-based board (nominal 8.0 kg/m²) mounted on dabs
- Insulation** 100mm mineral wool maximum density 40 kg/m³
- External (flanking) wall** Celcon Elements or aircrete 450-800 kg/m³ 50mm (min) cavity – clear, fully filled or partially filled with insulation – and masonry outer leaf

Note: All RDL Information provided here is accurate at the time of going to press. For details of any changes and to keep up to date with current assessments, visit www.robustdetails.com

Packs & Haulage



H+H UK Ltd operate throughout England, Scotland and Wales. Working closely with our transport partner, supply is maintained to the highest standards and journeys are minimised to save emissions. Aircrete is supplied on pallets, depending on the product and our pallet recycling scheme has now been in operation since 2009.

Product Marking

The product marking on packs includes the requirements under the Construction Products Regulation (CPR). CE mark must be applied to all products. Further to this a web address is also being applied to the pack which gives details of each product and the relevant Declaration of Performance (DoP) and CE marking.

See www.hhcelcon.co.uk/CPR

3.6N Standard 100

Code SRC100 Q1 178 18.38
Block wt = 7kg m²/pack 10
CE see hhcelcon.co.uk/CPR

Packaging Layout

The layout of the updated product marking is shown above:

The key areas are:

- CPR web address added
- Factory, Year, Day, and Time font size has been increased to improve readability. Pollington II factory code changed from P2 to Q to avoid confusion with the year identifier

Q = Factory Identifier	B = Borough Green P = Pollington I Q = Pollington II
1 = Year Identifier	1 = 2021 2 = 2022 3 = 2023 etc.
178 = Day number	A spreadsheet giving the date from the day number is available if required
18.38 =	Time of Day



CDM Regulations

The Health and Safety Executive (HSE) deals with all aspects of construction work in Great Britain. Construction is Britain's biggest industry and one of its most dangerous. The HSE has an initiative to improve health and safety standards during all construction work. This includes ensuring that building sites are adhering to safety procedure such as manual handling.

Block Weights

The Construction Industry Advisory Committee (CONIAC) Guidance suggests that repetitive handling of blocks over 20kg can increase risk of injury, therefore when designing or specifying

blocks, the lightest block that fulfills the performance criteria should be chosen.

Celcon Block weights can be found on individual product pages within this guide, see pages 8-15.

Aircrete Solutions

The cellular structure of aircrete ensures a product that is both strong and lightweight, thus providing significant productivity and health and safety advantages.

Pack Information

1200mm pallet size

		Block Thickness (mm) = T								
		75	100	140	150	200	215	275	300	355
Celcon Blocks and Celcon Foundation Blocks (440mm x 215mm)	Blocks/m² laid 9.88 (10mm joints)									
	Coverage per pack (m ²)	16	12	8	8	6	5	4	4	3
	Number of blocks per pack	160	120	80	80	60	50	40	40	30
	Pack width (mm) = W	1200	1200	1120	1200	1200	1075	1100	1200	1065
	Pack weight – Solar Grade (kg)*	-	660	-	-	-	590	-	-	-
	Pack weight – Standard Grade (kg)*	875	875	815	875	875	785	800	875	775
	Pack weight – High Strength (kg)*	-	1175	1095	1175	1175	1055	1075	1175	1045

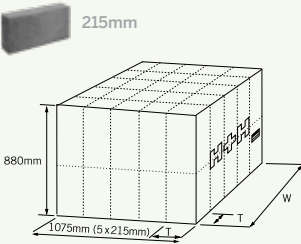

		Block Thickness (mm) = T								
		75	100	140	150	200	215	275	300	355
Celcon Foundation Blocks (325mm x 215mm)	Blocks/m² laid 13.27 (10mm joints)									
	Coverage per pack (m ²) – 10mm joint	-	-	-	-	-	-	-	2.6	-
	Number of blocks per pack	-	-	-	-	-	-	-	40	-
	Pack width (mm) = W	-	-	-	-	-	-	-	1075	-
	Pack weight – Standard Grade (kg)*	-	-	-	-	-	-	-	640	-
	Pack weight – High Strength/ Super Strength (kg)*	-	-	-	-	-	-	740	-	

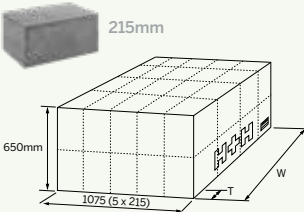

		Block Thickness (mm) = T								
		75	100	140	150	200	215	275	300	355
Celcon Plus Blocks (630mm x 215mm)	Blocks/m² laid 6.94 (10mm joints) 7.29 (2mm joints)									
	Coverage per pack (m ²) – 10mm joint	-	8.6	5.8	5.8	4.3	-	-	-	-
	Coverage per pack (m ²) – 2mm joint	-	8.2	5.5	5.5	4.1	-	-	-	-
	Number of blocks per pack	-	60	40	40	30	-	-	-	-
	Pack width (mm) = W	-	1200	1120	1200	1200	-	-	-	-
	Pack weight – Solar Grade (kg)*	-	470	440	470	470	-	-	-	-
	Pack weight – Standard Grade (kg)*	-	620	575	620	620	-	-	-	-
	Pack weight – High Strength/ Super Strength (kg)*	-	720	670	720	720	-	-	-	

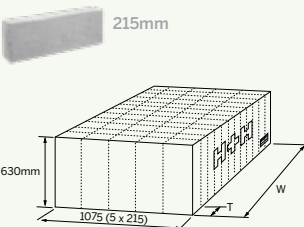

		Block Thickness (mm) = T								
		75	100	140	150	200	215	275	300	355
Jumbo Bloks (630mm x 250mm) 	Blocks/m² laid 6.28 (2mm joints)									
	Coverage per pack (m²) – 2mm joint	-	7.6	5.1	-	-	-	-	-	-
	Number of blocks per pack	-	48	32	-	-	-	-	-	-
	Pack width (mm) = W	-	1200	1120	-	-	-	-	-	-
	Pack weight – Solar Grade (kg)*	-	440	410	-	-	-	-	-	-
	Pack weight – Standard Grade (kg)*	-	575	535	-	-	-	-	-	-
	Pack weight – High Strength/ Super Strength (kg)*	-	670	625	-	-	-	-	-	-

		Block Thickness (mm) = T								
		75	100	140	150	200	215	275	300	355
Celcon Coursing Units (215mm x 65mm x 100mm) 	Coverage per pack (m²) – 10mm joint	-	10.1	5.1	5.1	-	-	-	-	-
	Coverage per pack (m²) – 2mm joint	-	8.7	4.4	4.4	-	-	-	-	-
	Number of blocks per pack	-	600	300	300	-	-	-	-	-
	Pack height (mm) = H	-	800	560	600	-	-	-	-	-
	Pack weight – Standard Grade (kg)*	-	645	455	485	-	-	-	-	-
	Pack weight – High Strength/ Super Strength (kg)*	-	870	610	650	-	-	-	-	-

* Pack weight excludes pallet

Haulage Details

At H+H we predominantly use articulated flatbed vehicles to move and manage our product deliveries.

The size of an H+H delivery is dependent on:

- Quantities ordered
- The product ordered
- The vehicle it is delivered on

To help gain maximum benefit we ask that when placing an order you simply request a full load.

Commercial Benefits

- Fewer drops at site
- Less yard time lost
- Less paperwork
- More time for dealing with customers

And its good for the environment

- Less vehicles clogging up the road
- Lower CO₂ emissions
- Less noise for the branch /site neighbours

* Check for current status

General Service Charter Haulage Conditions

- Load sizes are based on fully loaded articulated vehicles with a gross capacity of 44 tonnes.
- A level and firm hard standing must be available to receive deliveries. Pallets if required (and have not been requested on the delivery) should already be laid out.
- Waiting Time – The first hour on site or at merchant yard will not usually incur a waiting time penalty, but there will be a charge of £70.00 after the first hour has been exceeded from time of arrival, increasing to £300 after the second hour.
- Prices quoted are based on full loads delivered to mainland UK or mainland ports only, these will be delivered free of charge subject to Waiting Time 'c' above and clause 'i' below.
- Incomplete loads (see table of full load sizes below) will incur a charge for each pack less than full load capacity. The charge is £15.00 per pack within standard delivery area and £30.00 per pack outside the standard delivery area with a minimum charge £150 with a maximum 10 working day lead-time for delivery.
- Rigid vehicles are only available in restricted areas with a charge of £500 per vehicle and a maximum of up to 10 working days lead-time for delivery.
- If a wagon & drag combination is required, please apply to H+H for a price, based on application.
- Split loads are available at a charge of £150 per load within a 10-mile radius (ordered by a builders merchant for delivery part to site and remainder to the Merchants yard) if over 10 miles apart additional charges will apply.
- Dropping a trailer from a draw bar and making multiple drops from the rigid wagon is available upon request in advance. A standard charge of £75 charged to drop the trailer at site, in view of the driver. If the trailer is dropped away from the site in close proximity, it is the site's responsibility to advise a safe and legal location to do so. Requests will be considered and





prices agreed in advance. If agreed it may require a member of site to stay with the trailer whilst the driver traverses to and fro in order to deliver.

- j) Cancellations made after 12pm (midday) the day prior to dispatch or once the vehicle has been loaded will be subject to a restocking charge of 20% of the invoice value and cost of haulage already incurred if appropriate.
- k) Refusal on Delivery will be charged at cost of transport, restocking charges, plus unloading and reloading if applicable.
- l) A diversion charge, at cost of transport, will be payable should an order be diverted or returned before or upon arrival onsite or at the depot.
- m) Credit for returned goods will only be allowed after deduction of haulage and restocking costs of resalable product.
- n) If a driver is requested to park outside a site due to lack of space and a parking ticket is enforced, the charge will be forwarded to the customer for reimbursement.

Site Completions

- i Each site (where we have delivered full loads) for the purpose of site completion will be allowed one incomplete load at no additional charge, with a maximum of 10 working days lead-time for delivery.

Deliveries

- i Our normal delivery hours are between 8am and 4pm. Other times can be arranged but must be agreed in advance, subject to conditions outlined in the Service Charter.
- ii 48-hour notice of delivery will be given.
- iii Full loads of stocked product delivered on articulated vehicles will be made within 3-5 working days after receipt of order subject to market conditions and product availability.

Pallet Information

- i All deliveries to a Builders Merchants yard will be made on pallets.
- ii H+H UK's Coursing Unit deliveries whether to depot or site will be made on pallets.
- iii Deliveries to site are not made on pallets. Non-returnable pallets can be provided at £750 per pallet for new customers.
- iv A free of charge pallet collection service is available. Phone 0800 282488 to arrange. Collections require a minimum of 50 pallets from any supplier, not just H+H UK Ltd. Our pallet collection partner will manage the re-distribution for you.

Typical Full Loads (Maximum Packs per Vehicle)*

Product Type	Articulated Vehicles	
	440 x 215mm blocks	630 x 215/200mm blocks
Solar (2.9N/mm ²)	40	50
Standard (3.6N/mm ²)	34	40
High Strength (7.3N/mm ²)	32	36
Super Strength (8.7N/mm ²)	32	36



For further information and to check our most up-to-date product range, or to find your nearest stocking merchant, please visit our website or contact the following departments:

Sales

For sales enquiries or to find your local stockist please contact:
Tel: 01732 886444
Fax: 01732 887013

Technical

For technical enquiries please contact:
Tel: 01732 880580
Fax: 01732 887013
Email: technical.services@hhcelcon.co.uk

Head Office

H+H UK Limited
Celcon House
Ightham, Sevenoaks
Kent TN15 9HZ
Tel: 01732 886333

www.hhcelcon.co.uk

H+H UK will always endeavour to reflect our product range and technical information as accurately as possible. We may however, need to update both from time to time during the life of this brochure. Please check with either our Sales or Technical departments to obtain the latest information prior to specification and purchase.

CELCON
PRODUCED IN THE UK
AIRCRETE | EST. 1949
INSIDE

H+H
PARTNERS IN WALL BUILDING

